

# □ 10 までのかず・すうじ

● えのかずをかぞえて、そのすうじをえらんでせんでおすびましょう。

● すうじのれんしゅうをしましょう。

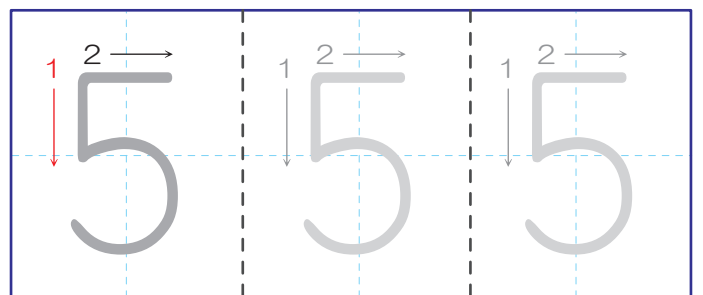
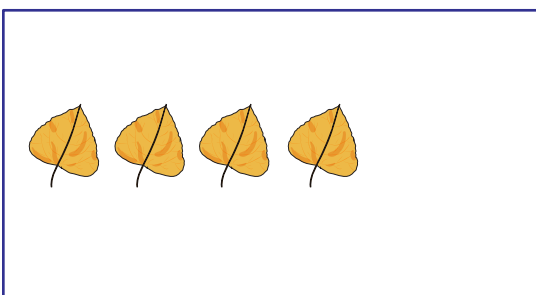
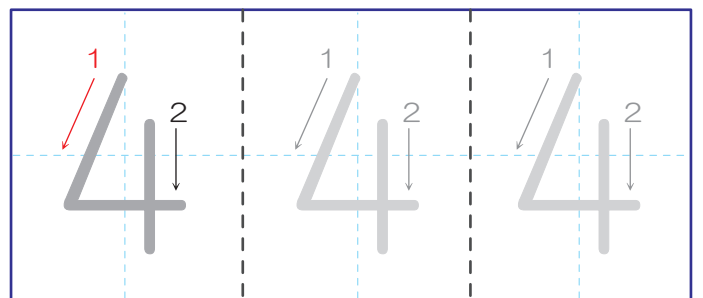
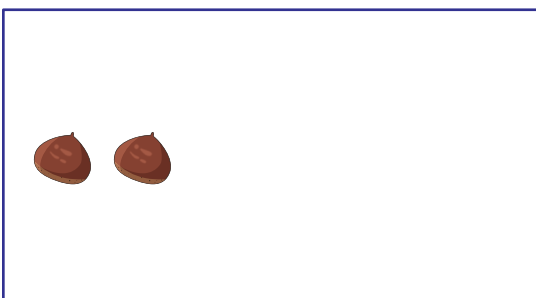
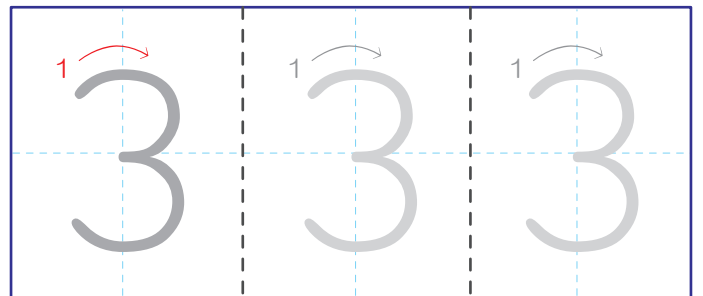
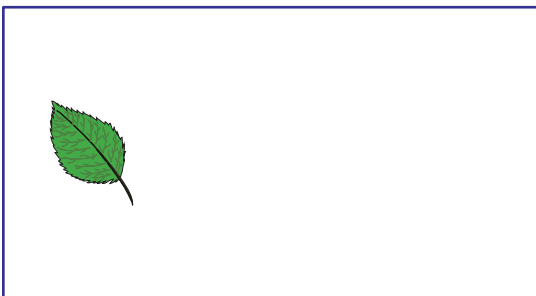
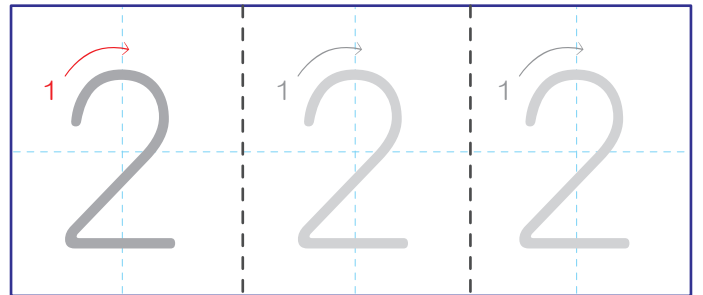
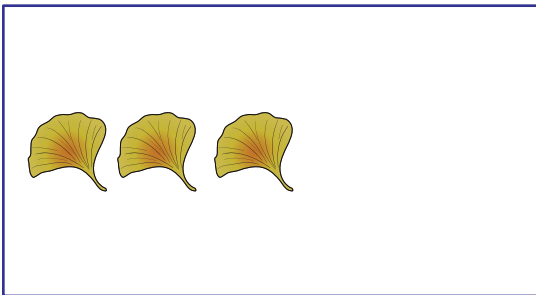
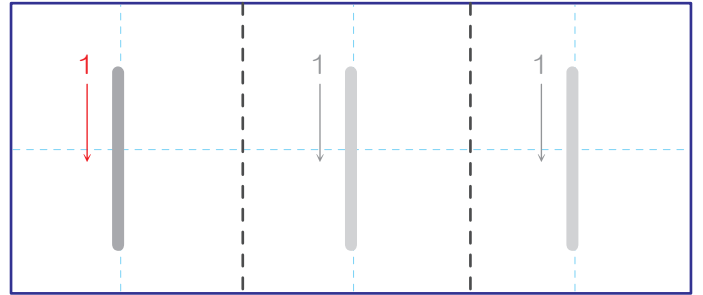
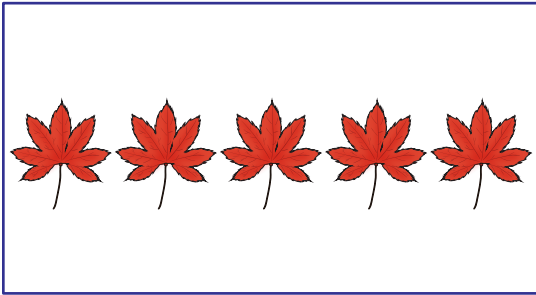

# □ 10までのかず・すうじ

● えのかずをかぞえて、そのすうじをえらんでせんでおすびましょう。

● すうじのれんしゅうをしましょう。

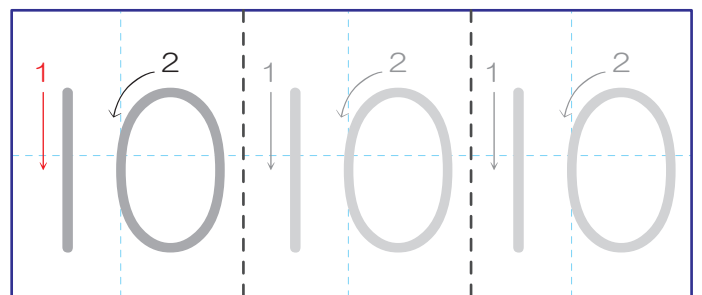
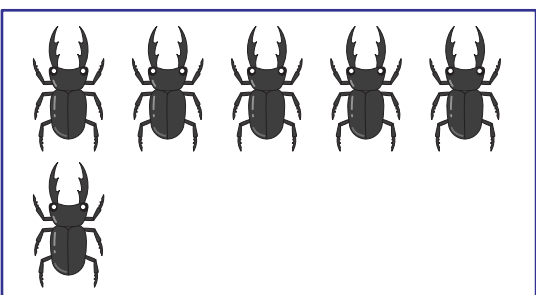
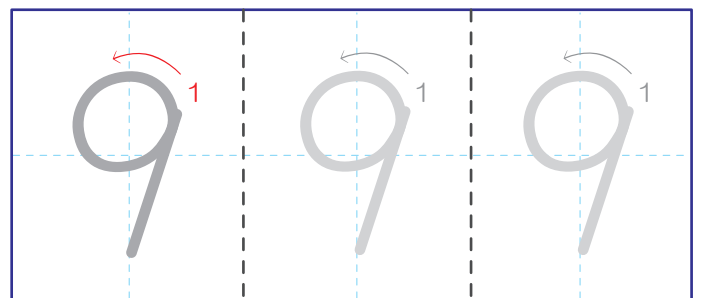
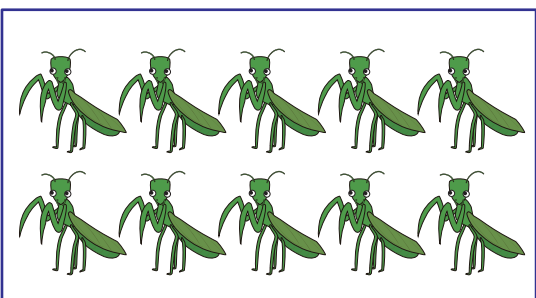
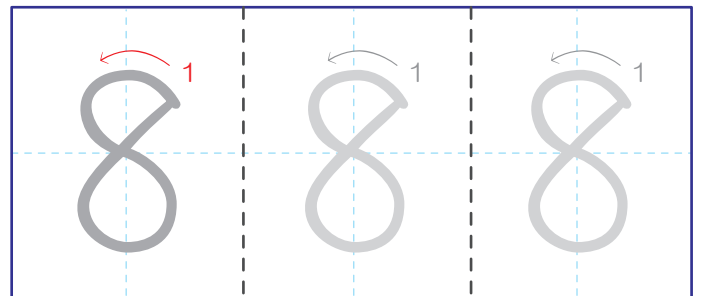
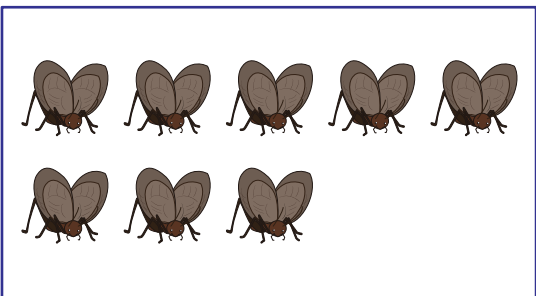
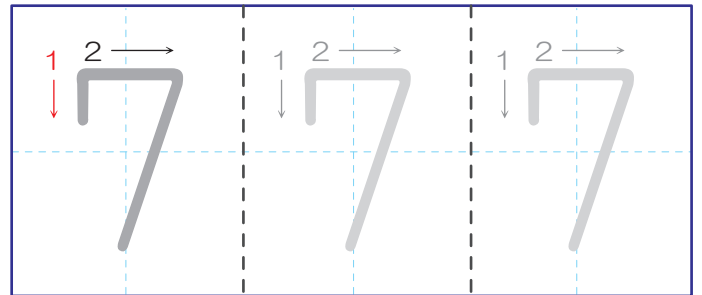
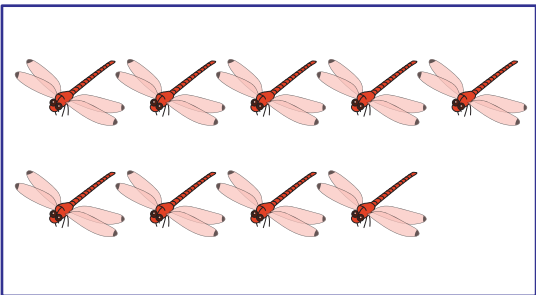
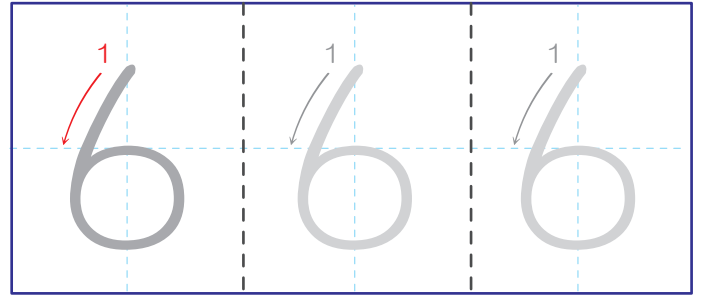
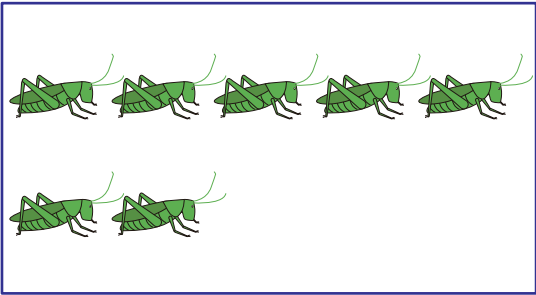

# □ 10までのかず・すじ

|    |    |     |
|----|----|-----|
|    |    | なまえ |
| がつ | にち |     |

おなじ かずを せんで おすびましょう。すじを なぞりましょう。

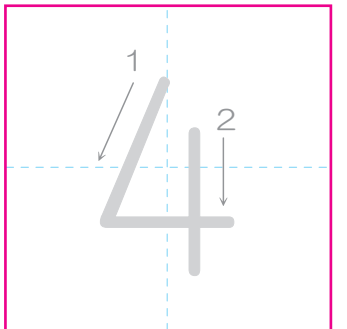
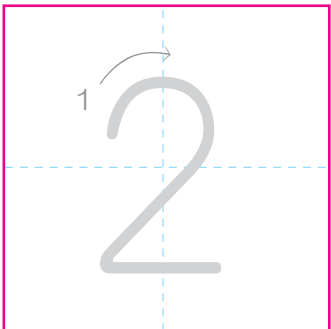
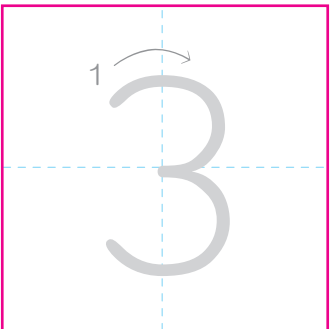
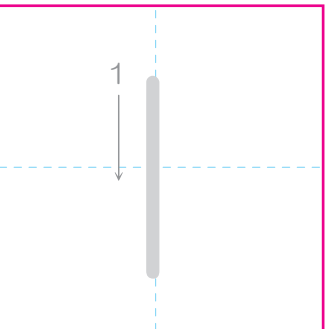
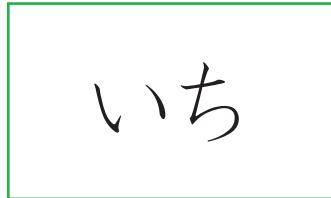
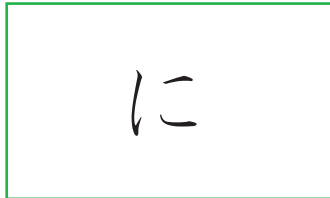
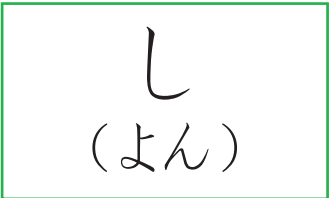
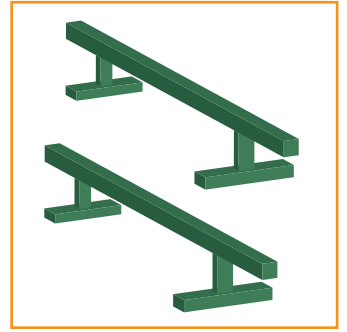
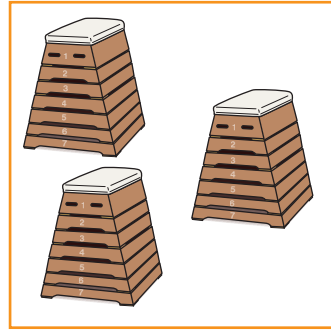
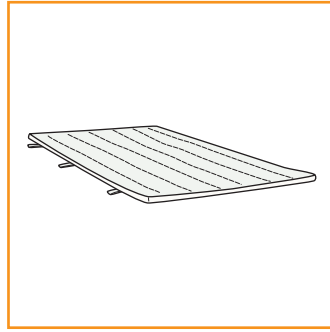
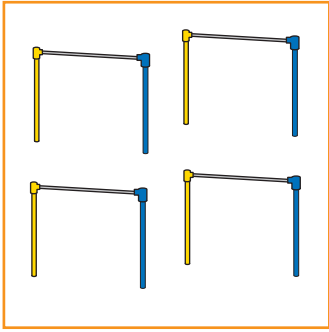

□ 10までのかず・すうじ

|    |    |     |
|----|----|-----|
|    |    | なまえ |
| がつ | にち |     |

おなじ かずを せんで おすびましょう。すうじを なぞりましょう。

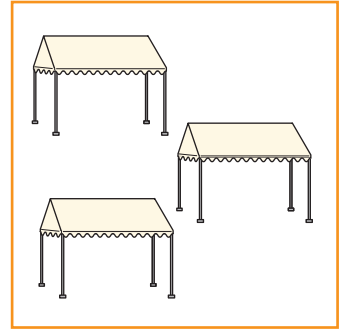
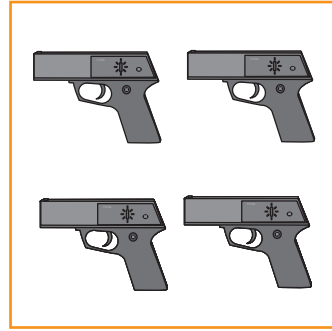
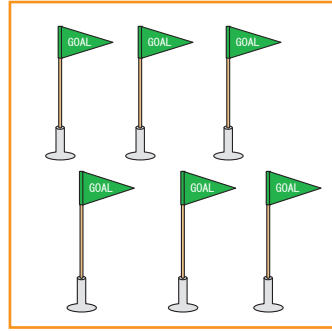
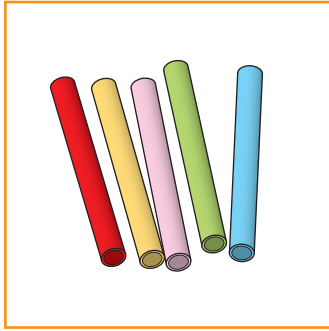

し  
(よん)



ご



ろく



さん

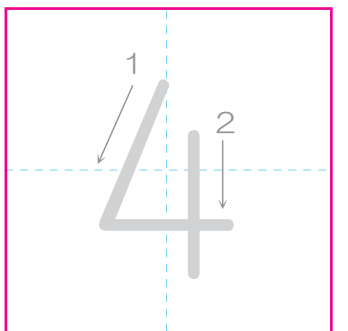
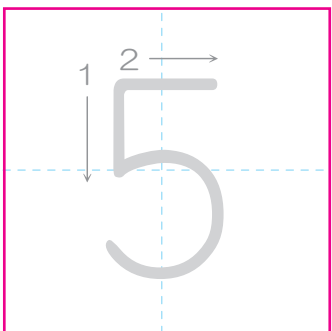
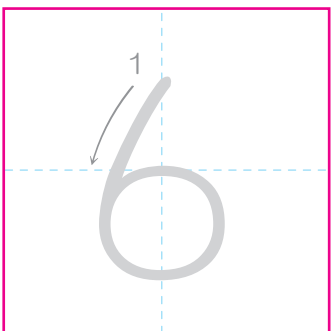
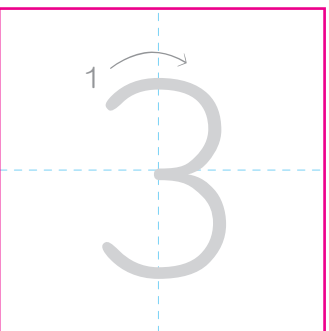

# □ 10までのかず・すうじ

|    |    |     |
|----|----|-----|
|    |    | なまえ |
| がつ | にち |     |

おなじ かずを せんで おすびましょう。すうじを なぞりましょう。

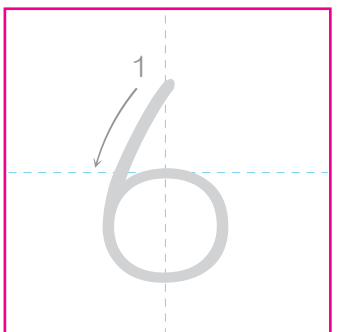
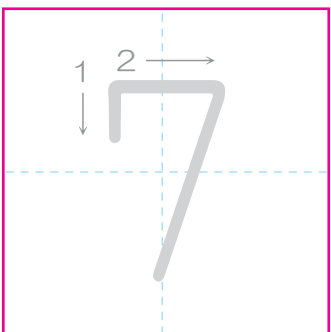
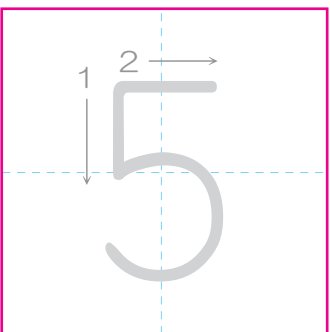
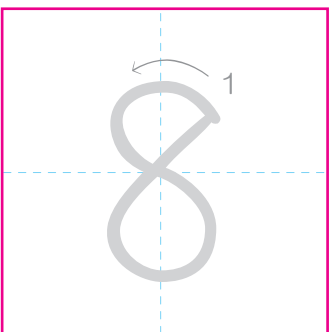
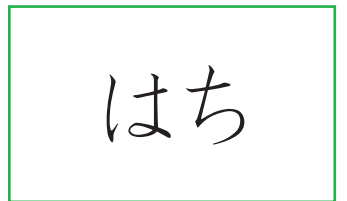
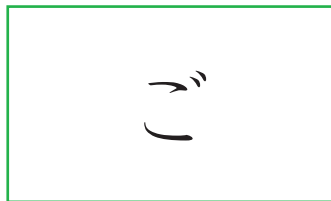
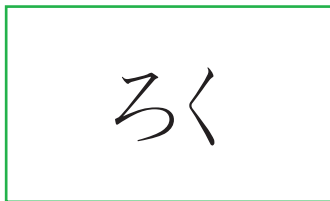
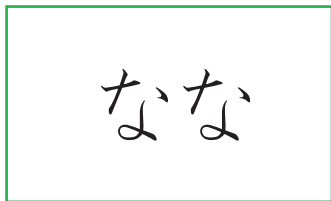
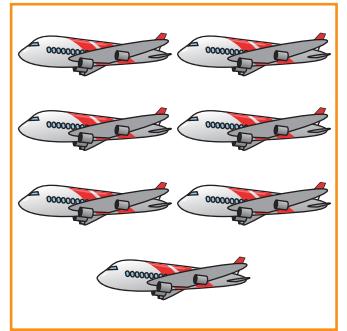
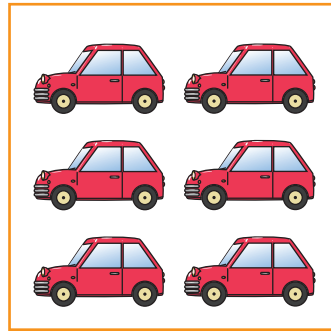
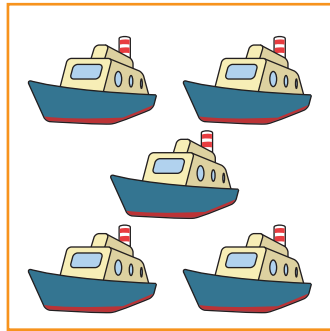

# □ 10までのかず・すうじ

|    |    |     |
|----|----|-----|
|    |    | なまえ |
| かつ | にち |     |

おなじ かずを せんで おすびましょう。すうじを なぞりましょう。

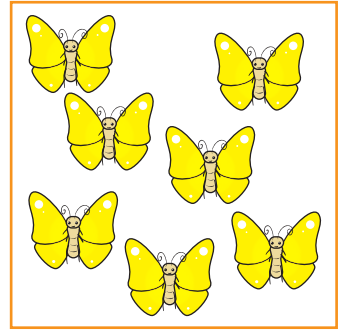
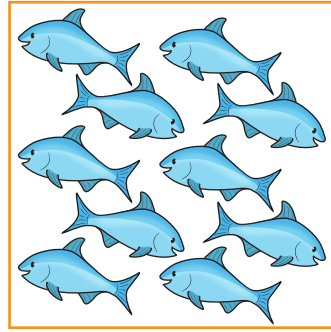
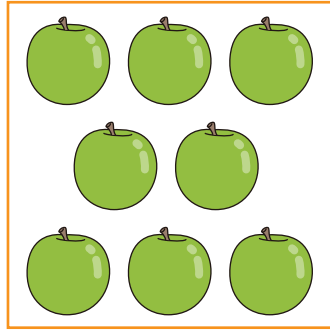
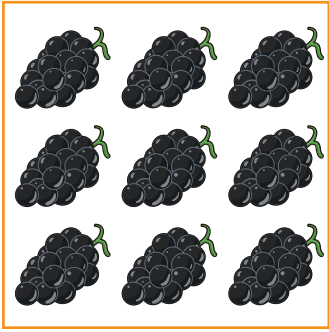

なな



く  
(きゅう)



はち



じゅう

